

Sunhouse

INSTRUCTION MANUAL

Installation and Operating

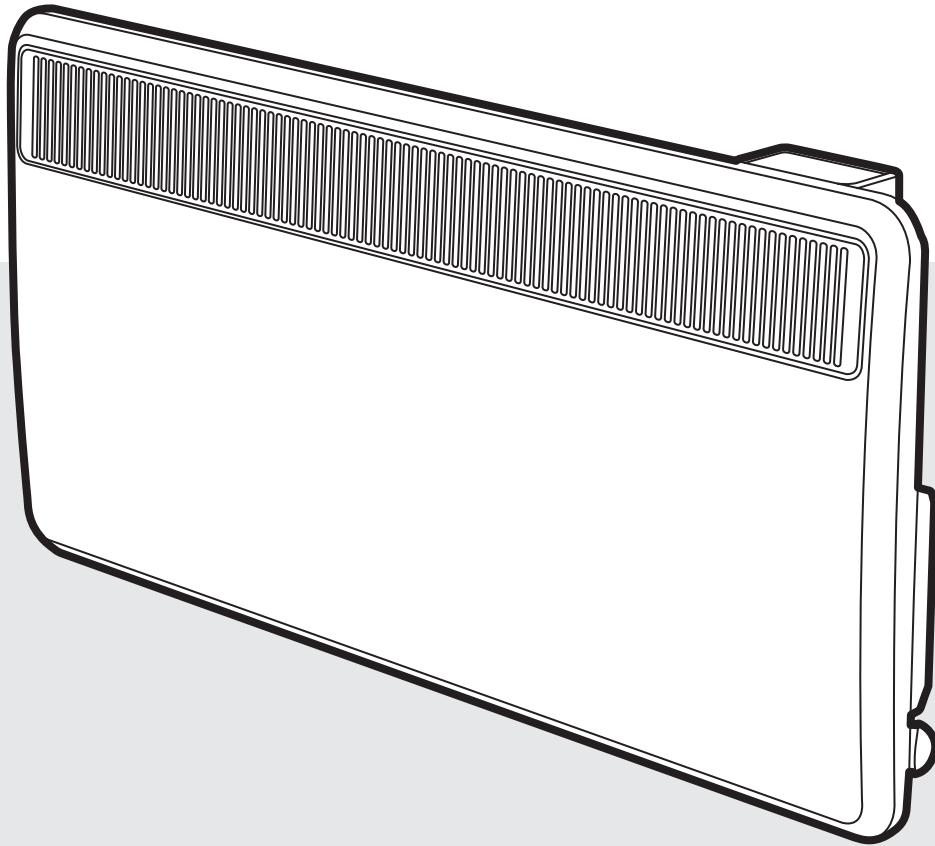

Sunhouse SPHN Panel Heater

Models: SPHN050E / SPHN100E / SPHN150E / SPHN200E

These instructions should be read carefully and retained for future use. Note also the information presented on the appliance.



IMPORTANT
THESE INSTRUCTIONS SHOULD BE READ CAREFULLY AND RETAINED FOR FUTURE REFERENCE. Note also the information presented on the appliance

CAUTION: FAILURE TO FOLLOW THESE INSTRUCTIONS MAY CAUSE INJURY AND/OR DAMAGE AND MAY INVALIDATE YOUR GUARANTEE

IMPORTANT SAFETY ADVICE

When using electrical heaters, basic precautions should always be followed to reduce the risk of fire, electrical shock, and injury to persons, including the following:

IMPORTANT – The wall bracket supplied with the heater must be used.

IMPORTANT – All packaging should be disposed of in an appropriate manner.

OVERHEATING WARNING

WARNING - In order to avoid overheating, do not cover or obstruct the heater. Do not place material or garments on the heater, or obstruct the air circulation around the heater, for instance by curtains or furniture, as this could cause overheating and a fire risk. NEVER cover or obstruct in any way the heat outlet slots at the top of the heater or the air inlet slots in the base of the heater.

WARNING - THE SURFACES ON THIS HEATER CAN BE HOT. The heater carries a warning 'DO NOT COVER' to alert the user to the risk of fire that exists if the heater is accidentally covered.

CAUTION - Some parts of this product can become very hot and cause burns. Particular attention has to be given where children and vulnerable people are present.

For your safety this heater is fitted with a thermal cut-out. In the event that the product overheats for some reason, the cut-out prevents excessive temperatures on the product by cutting the power to the heater. Once the heater has cooled down, it will reset automatically, it will continue to cycle on and off automatically until the reason for overheating is removed. The display screen may flash red to indicate the product has overheated. To reset the display, remove the obstruction and hold Enter for 10 seconds.

SUITABLE APPLICATIONS

WARNING - This heater is suitable for normal domestic household purposes and should not be used in any other type of environment. This product should only be used in the country where it was purchased from by a recognised commercial retailer. Do not use outdoors. Do not install if the product is damaged.

SERVICING AND REPAIRS

WARNING - Servicing and product repairs should only be undertaken by the manufacturers approved service agent or a similarly trained or qualified person, using only exact manufacturer approved spare parts.

PLEASE NOTE: Household dust, lit cigarettes, candles and oil burners, combined with the convection effect of electric heaters can cause significant soot deposits to build up on the surface directly above and to the sides of the heater. This is not a fault of the heater. Extensive burning of candles or smoking in the operating environment of this product can produce heavy discolouration within a few months of use.

OPERATING WARNINGS

IMPORTANT: Remember to observe all safety warnings and precautions when operating the heater on the automatic or timer modes, either attended or unattended since a fire risk exists when the heater is accidentally covered or displaced.

CAUTION: Do not use if the heater's mains power lead is damaged. If the supply cord is damaged it must be replaced by the installer or an approved service partner.

ELECTRICAL INSTALLATION

WARNING - The electrical installation of this heater must be carried out by a suitably qualified or trained electrician, and be in strict accordance with the current wiring Regulations BS 7671. The supply must be connected via a switched fused spur with a fuse rated suitably for the appliances flex. Failure to follow these instructions will mean that the manufacturer's instructions have not been adhered to. THERE ARE NO EXCEPTIONS.

WARNING - Minimum clearances and IP zone requirements must be adhered to in accordance with the current wiring regulations. The wires in this mains lead are coloured in accordance with the following code:

GREEN AND YELLOW: EARTH

BLUE: NEUTRAL

BROWN: LIVE

- This heater must be earthed
- Not suitable for connection via a plug top
- Do not locate the heater immediately below a fixed electrical point i.e. socket outlet.

The heater is fitted with a length of flexible cable type H05VV-F size 3 x 1.0mm² for 500W to 2kW models for connection to the fixed wiring of the premises through a suitable connection box positioned adjacent to the heater. A means for disconnection must be incorporated in the fixed wiring of the premises in accordance with the current wiring regulations. The supply circuit to the heater must incorporate a double pole isolating switch having a contact separation of at least 3mm. Products that are supplied without a plug are for installation into the fixed wiring of the property, via a suitable double pole switched fused spur with a fuse rated suitably for the appliances flex. Typical fuse ratings for 230V equipment - Up to 700W = 3A, over 700W = 13A.

In installation the supply cord may be cut to the appropriate length for the electrical connection point. Excess cable should not be inserted and stored behind the heater.

WARNING: This heater must not be connected to the electricity supply via an external switching device (such as a timer) or a circuit that is regularly switched on and off by the utility supplier. Failure to follow this warning could result in the heater's thermal cut-off being inadvertently reset and could create a fire hazard. Cables/flexes that are supplied pre-fitted to the product must NOT be extended.

CHILD SAFETY

WARNING - This appliance is not intended for use by persons (including children) with reduced physical, sensory or mental capabilities, or lack of experience and knowledge, unless they have been given supervision or instruction concerning use of appliance by a person responsible for their safety.

This appliance can be used by children from 8 years and above and persons with reduced physical, sensory or mental capabilities or lack of experience and knowledge if they have been given supervision or instruction concerning use of the appliance. Children shall not play with the appliance. Cleaning and user maintenance shall not be made by children without supervision. Children of less than 3 years should be kept away unless continuously supervised.

Children aged from 3 years and less than 8 years shall only switch on/off the appliance provided that it has been placed or installed in its intended normal operating position and they have been given supervision or instruction concerning use of the appliance in a safe way and understand the hazards involved. Children aged from 3 years and less than 8 years shall not regulate and clean the appliance or perform user maintenance. This product contains a replaceable battery.

WARNING - KEEP BATTERIES OUT OF REACH OF CHILDREN.

WARNING - Packaging should be disposed off responsibly as the EPS used could be a potential choking hazard for children.

Energy Related Product Directive

This product complies with Lot20 of the Energy Efficiency Directive (2015/1188).

Type of heat output/ room temperature control	
With electronic room temperature control	Yes
Electronic room temperature control plus week timer	Yes
With open window detection	Yes
With adaptive start control	Yes

Technical Details

Model Identifier(s):		SPHN050E	SPHN100E	SPHN150E	SPHN200E
Nominal heat output	P _{nom}	0.5 kW	1 kW	1.5 kW	2 kW
Height (mm)		430	430	430	430
Width (mm)		450	620	690	860
Depth (mm)		108	108	108	108
Minimum heat output (indicative)	P _{min}	N.A.	N.A.	N.A.	N.A.
Maximum continuous heat output	P _{max,c}	0.5	1	1.5	2
Auxiliary electricity Consumption					
At nominal heat output	e _{lmax}	0.00	0.00	0.00	0.00
At minimum heat output	e _{lmin}	0.00	0.00	0.00	0.00
In standby mode	e _{lSB}	<0.0005	<0.0005	<0.0005	<0.0005
With open window detection			Yes		
With adaptive start control			Yes		

All Models	
Controls	Digitally controlled, Electronic Thermostat accurate to ($\pm 0.2^{\circ}\text{C}$) Timer modes: •7 Day Programmable User Timer Continuous heat modes: •Timer, Manual, Frost Protect, Off
Controller UI	•Segmented display with white backlight •Capacitive buttons with audio feedback •User replaceable battery (coin-type)
Controller Functions	•Open window detection, Adaptive-start, Advance time period •Adjustable SP range ($7\text{-}32^{\circ}\text{C}$)
Construction	•Durable epoxy-polyester powder coated steel casing with forward facing grille •Advanced controls with cap-sense technology for total flexibility of heating
Element	Compact, finned, mineral filled sheathed element
Installation	•H-frame wall bracket
Safety	•Thermal cut-out. Auto reset type •Overheat detection
IP Rating	IP24
Battery	3V coin cell battery, type CR2032, $T85^{\circ}\text{C}$, to backup real time clock. Battery life >5 years.
Supply	1.3 metres fitted, 3 core for fused spur installation, 1/N/PE $\sim 230\text{-}240\text{ V}$, 50Hz Class I, with earth wire
Colour / Finish	Metal Chassis, Control Moulding - Traffic White (RAL 9016)
Approvals	CE, UKCA, BEAB
Warranty	1 years
Country of Origin	United Kingdom
Manufacturer	Sunhouse, Millbrook House, Grange Drive, Hedge End, Southampton, SO30 2DF

General Information

Please read the instructions closely before first using the product. There is also a quick-start guide on the page 8 if you need a reminder of how to use the basic functions in the future.

The heater is designed for wall mounting using the wall bracket supplied. It should only be operated when in the upright position as shown - see Fig.3 and Fig.4. All models are splash proof to IP24. Before connecting the heater check that the supply voltage is the same as that stated on the heater.

Wall Mounting Instructions

IMPORTANT - The wall bracket supplied with the heater must be used and the heater must be installed in the correct orientation. The fixings should be used to secure the bracket to the particular wall on which the heater will be installed. The heater should be positioned observing the minimum clearances stated around the heater - see Fig. 1, Fig. 3 and Fig. 4.

MODEL	A	B	C	D	E	F
SPHN050E	116mm	269mm	365mm	430mm	450mm	108mm
SPHN100E	286mm	269mm	365mm	430mm	620mm	108mm
SPHN150E	356mm	269mm	365mm	430mm	690mm	108mm
SPHN200E	526mm	269mm	365mm	430mm	860mm	108mm

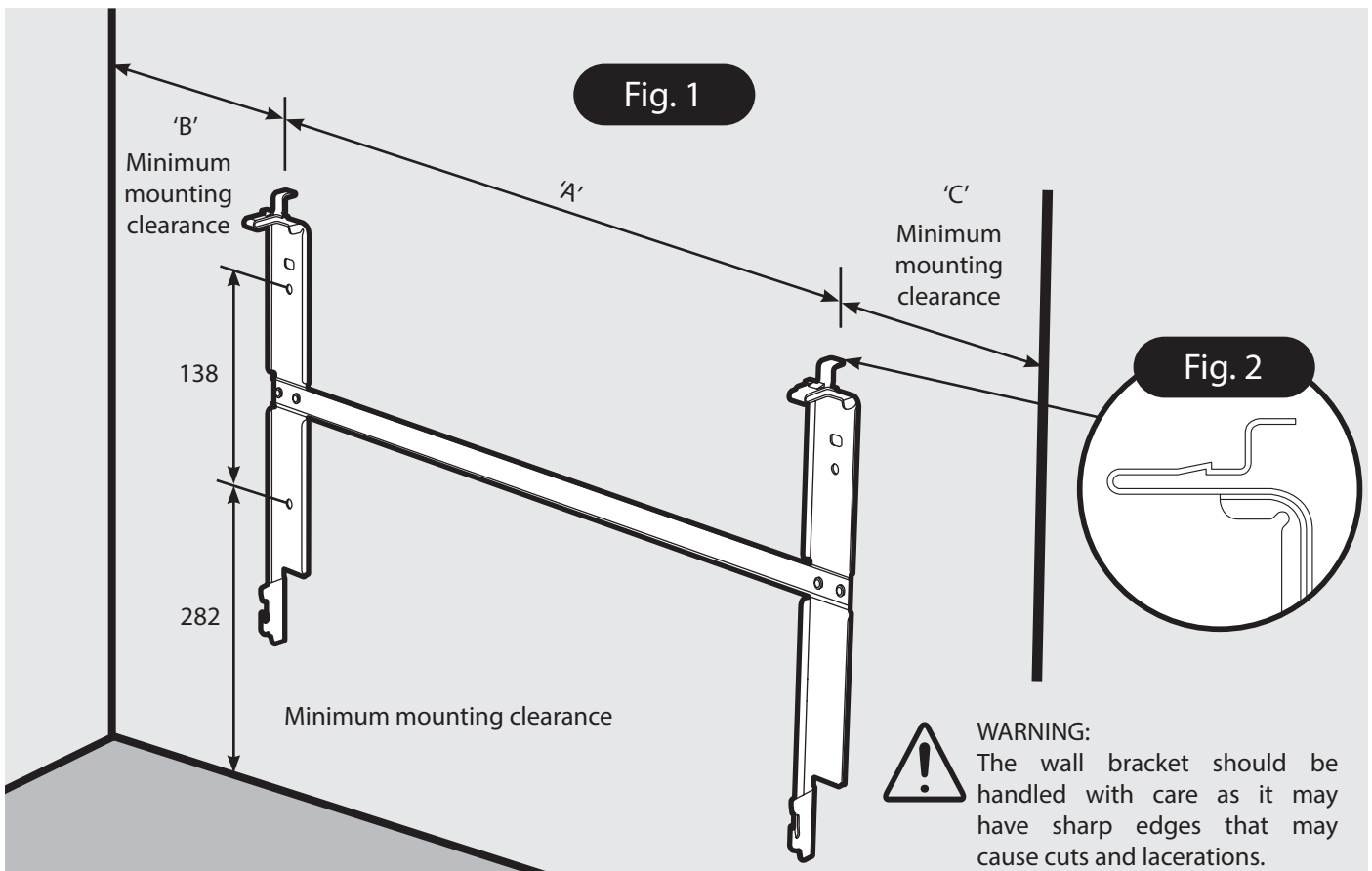

To mount the heater to the wall:

1. Remove wall mounting bracket from the back of the heater by depressing the spring latch at the side of each bracket - see Fig.2.
2. Fix the wall bracket securely to the wall through the four screw holes. Ensure only screw fittings provided are used for the particular wall type.
3. Present the heater to the wall bracket and engage bottom slots in the back with bracket hooks.
4. Press heater into locked position and ensure the clips on the top are engaged.

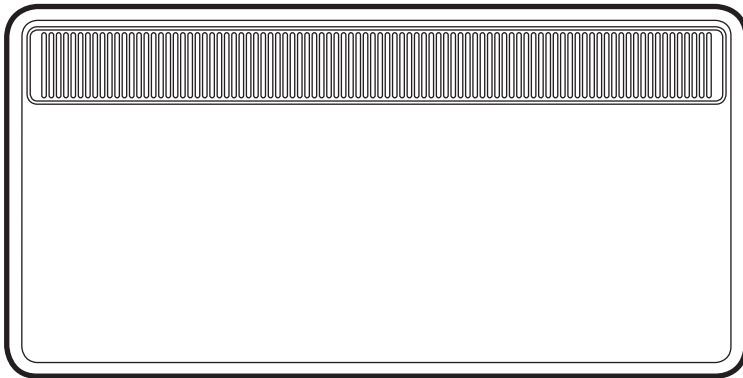



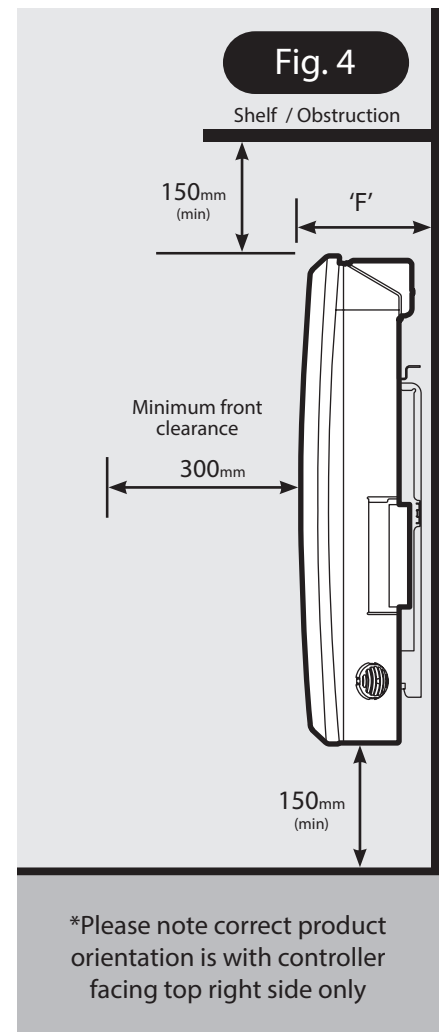
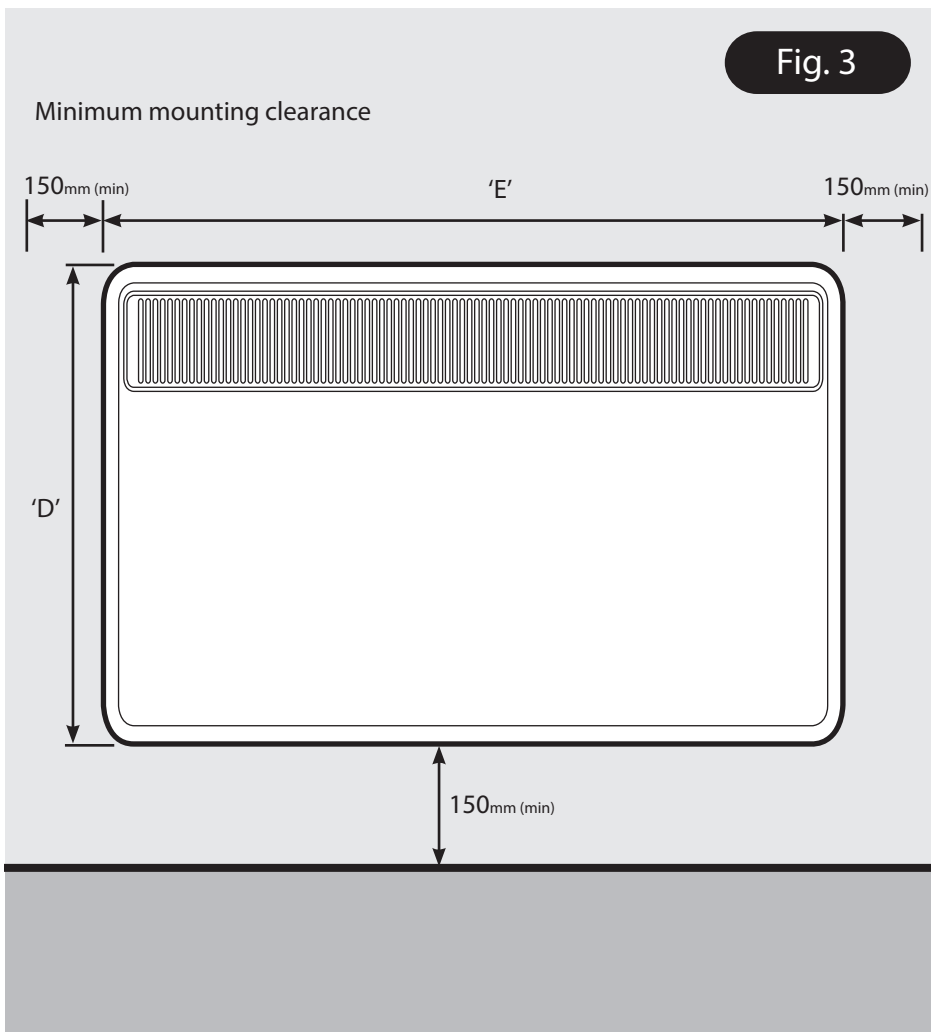

WARNING:
This product is heavy and care should be taken in installation



Quick Start Guide

How does the heater control work?

The control allows you to choose when you want heat and at what temperature. When using a timer mode (see below)  will display on the home screen to tell you when the heater is maintaining the temperature displayed. The current time will be displayed when the heater is outside of a timed heating period.

When  Manual,  Schedule or  Frost modes are being used the heater will always maintain the temperature shown on the home screen.

Set the Time

To set the date and time on the heater, press Menu, then press Up three times to highlight the  Date & time icon, press Enter. Use the Down and Up to increase/decrease the hour, press Enter to confirm. Repeat this process to set the minutes, Day, Month and Year. Press Enter to confirm and return to home screen.

Set the Temperature

The temperature shown on the display is the target room temperature known as Setpoint. This is the temperature that the heater will maintain during the heating periods. If the room temperature is above this temperature then the heater will not operate. The heater leaves the factory with this temperature set at 21°C which represents a typical comfortable room temperature. If you require a different room temperature then press either Down or Up until the display shows the temperature you require

Your heater comes pre-programmed with four heating periods. These periods set the time and temperature at which the heater operates in Comfort ON mode. These four periods are:

- P1: 07:00 – 09:00 21°C
- P2: 10:00 – 12:00 7°C
- P3: 13:00 – 15:00 7°C
- P4: 17:00 – 21:00 21°C

The controls are located on the top of the heater. The heater is fitted with an adjustable electronic controller consisting of a display screen and six touch sensitive buttons.

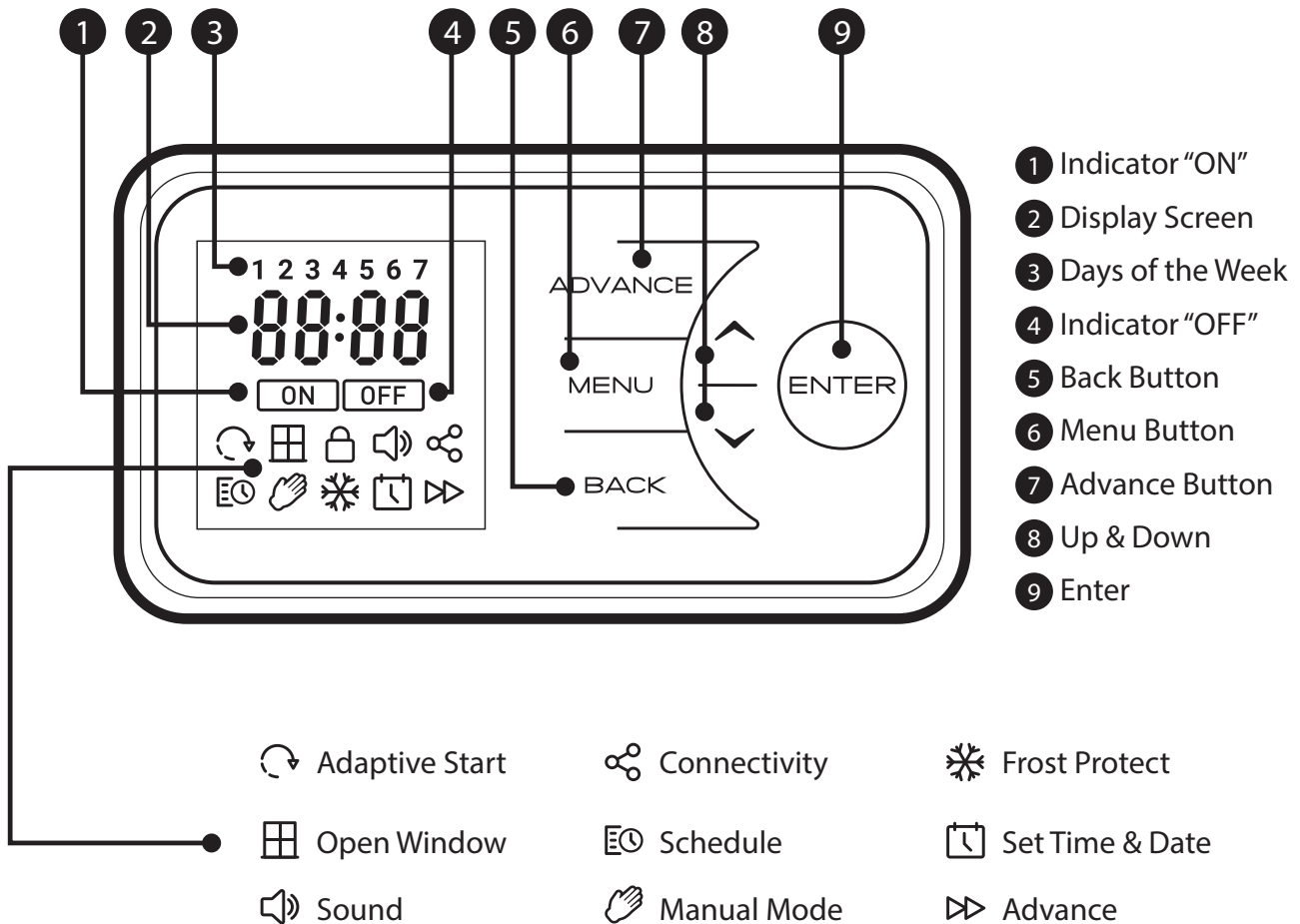

The heater is fitted with an adjustable thermostat enabling the room temperature to be controlled. The minimum room temperature is 7°C. The maximum temperature is set to 26°C by default, however, this can be increased to 32°C if required. A temperature of 21°C would be comfortable for most people.

Note: Your heater may produce some noise during operation. This noise is caused by the expansion and contraction of the element as it changes temperature, and is normal for this type of product. Whilst the noise produced is usually very quiet, certain environmental factors can make it more noticeable, such as hard flooring or minimal furnishings.

Note: Should the heater fail to operate, this may be due to the room temperature being higher than the thermostat setting.

Control Functions

The heater controls can be easily adjusted by using the six buttons on the user interface.

1. The Display Screen shows the options available at each stage of adjustment
2. Menu - displays the main options list
 - 🕒 Schedule: Set the program times and temperatures
 - 👉 Manual Mode: Toggle between Manual / Standby
 - ❄ Frost Protect: Set the frost protect temperature
 - 📅 Set Time & Date: Set the Date and Time
3. Back returns to the previous programming stage
4. The UP and DOWN buttons are used to navigate through the menus and alter setting values. The UP and DOWN buttons are also used to adjust the required room temperature on the main screen.
5. Enter is used within the menu options to confirm settings. On the main screen pressing Enter will display the Device Name as a 4 digit PIN. The timed periods during which the heater is providing heat are defined as Comfort On (this is displayed in the middle of the screen). Outside of heating periods the heater will not deliver heat and these periods are called Comfort Off. While constant heat modes are active, the mode of operation is displayed at the bottom of the screen e.g. Manual 👉
6. The Advance button overrides the heating settings and changes the operational state of the heater. When a timer has been selected, the Advance function allows you to begin the next period early. If the heater is in a Comfort Off period and you want heat - press the Advance button. If the heater is in Comfort On and you don't want heat, press the Advance button and it will go off until the beginning of the next Comfort On Period.

If the heater is in a constant mode of operation, Advance can be used to switch the heater on and off.

Main Screen

After 30 seconds the heater will default back to the Main Screen. Here the chosen temperature is displayed along with the mode of operation. Any use of the Advance function will be displayed here.

When left inactive for a long period of time this display will “sleep” and the text will disappear. Press any button for its return.

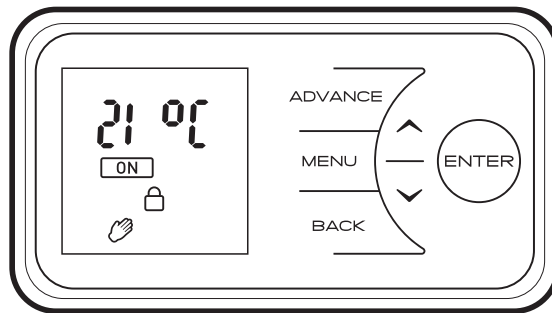

NOTE:
Pressing Enter will show the Device Name as a 4 digit pin.



NOTE:
The display screen will return to the main screen after a period of 30 seconds inactivity

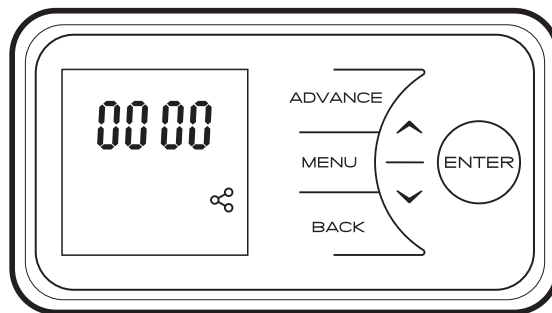

Setting the Date and Time

The heater incorporates a real time clock with calendar function. The clock has a battery backup that will keep the clock running in the event of a mains power outage.

To adjust the date and time follow the steps below

- Press the Menu button
- Press Up button 3 times
- Press Enter when the  Date & time Icon is highlighted
- Press Enter to set Time
- Press Down / Up to set the Hour, then press Enter to confirm
- Press Down / Up to set the Minutes, then press Enter to confirm
- Press Down / Up to set the Day, then press Enter to confirm
- Press Down / Up to set the Month, then press Enter to confirm
- Press Down / Up to set the Year, then press Enter to confirm

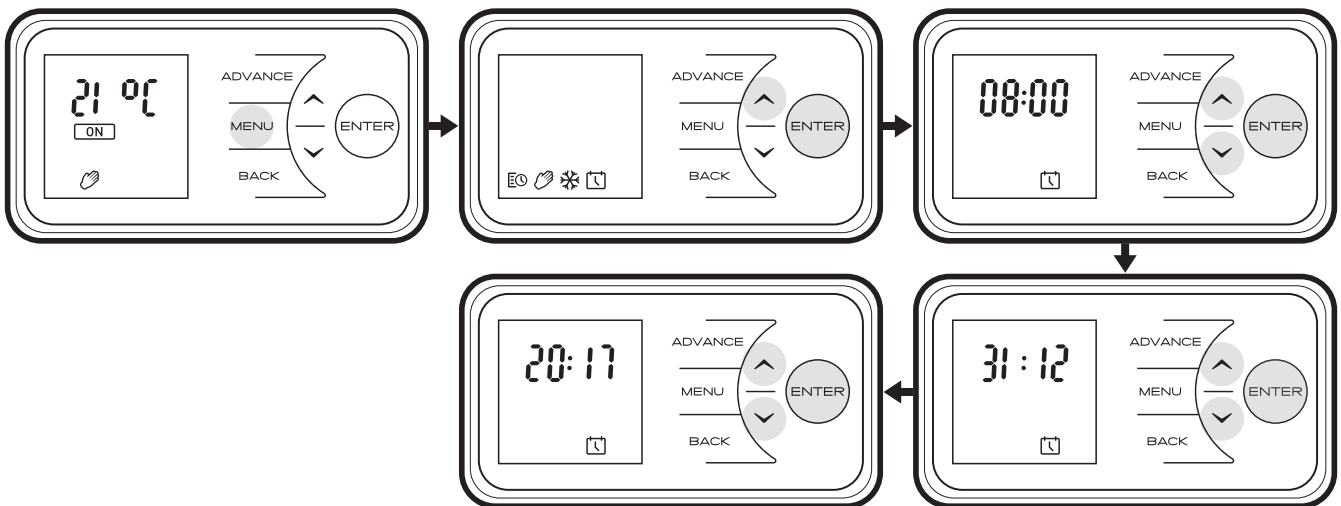



Mode of Operation

User Timer

Provides greatest flexibility to the user. Four time slots are available throughout the day and these can be customised for each day of the week. See 'Setting a Timer' on page 14 for instructions on adjusting these from the factory default time periods & temperatures.

The heater can also maintain a constant room temperature using the following modes:

 Manual Mode - Heats the room to a comfortable temperature of 21°C.

 Frost Protect - Maintains a room temperature of 7°C. This mode should be used to provide protection against frost as indicated by the  Frost icon.

Standby - Select Standby to switch off the heating element. Heat will not be provided. To activate standby:

- Press Menu button
- Press Up highlight the hand icon 
- Press Enter
- Toggle to Off



NOTE:

In all modes Down and Up can be used to adjust the required room temperature. In timer mode, this change is temporary and the heater will set the room temperature based on the saved heating profiles.





NOTE:

It is recommended that the timer mode is used as doing so can reduce the running cost. Operating the appliance in the permanent heating modes may result in increased running costs.

Selecting Timer Mode

User Timer - To activate User timer mode:

- Press Menu Button
- When the  Schedule Icon is highlighted Press Enter
- With  highlighted press the Enter Button to activate User Timer, the backlight will flash and the screen will return to the home screen.

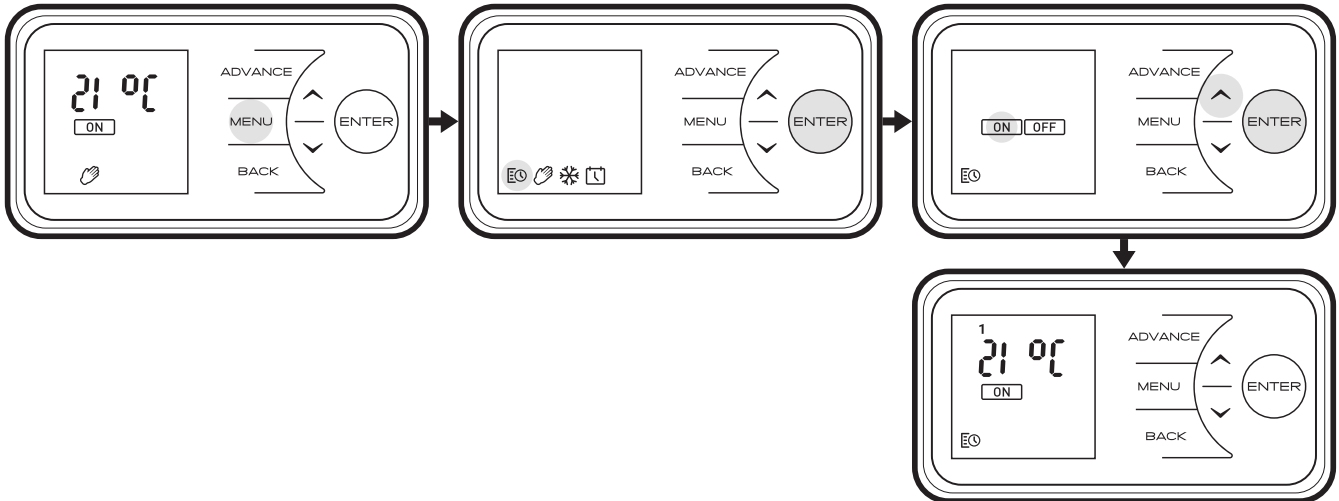

Setting a Timer

User Timer - To re-programme the factory default Timer Modes:

- Press Menu Button
- When the  Schedule Icon is highlighted Press Enter
- Press Up twice then press Enter

Days of the week are now displayed at the top of the screen

- Day 1 = Monday
- Day 2 = Tuesday
- Day 3 = Wednesday
- Day 4 = Thursday
- Day 5 = Friday
- Day 6 = Saturday
- Day 7 = Sunday

- Press Enter to Modify Day 1 or Press Up to navigate to the desired day and Press Enter to Select

1. P1 will be displayed on screen
2. Press Enter to select P1, to navigate to P2, P3 or P4 press Up and press Enter to select
3. ON will be highlighted, press Enter to set the on Time
4. Press Down or Up to adjust the on Hour time, press Enter to Confirm
5. Press Down or Up to adjust the on Minute time, press Enter to Confirm
6. Press Down or Up to adjust the Temperature setting, press Enter to Confirm
7. Press Down or Up to adjust the off Hour time, press Enter to Confirm
8. Press Down or Up to adjust the off Minute time, press Enter to Confirm

Press Enter to modify Programme P2, follow steps 1-8, Press Up to skip to P3
 Press Enter to modify Programme P3, follow steps 1-8, Press Up to Skip to P4
 Press Enter to modify Programme P4, follow steps 1-8

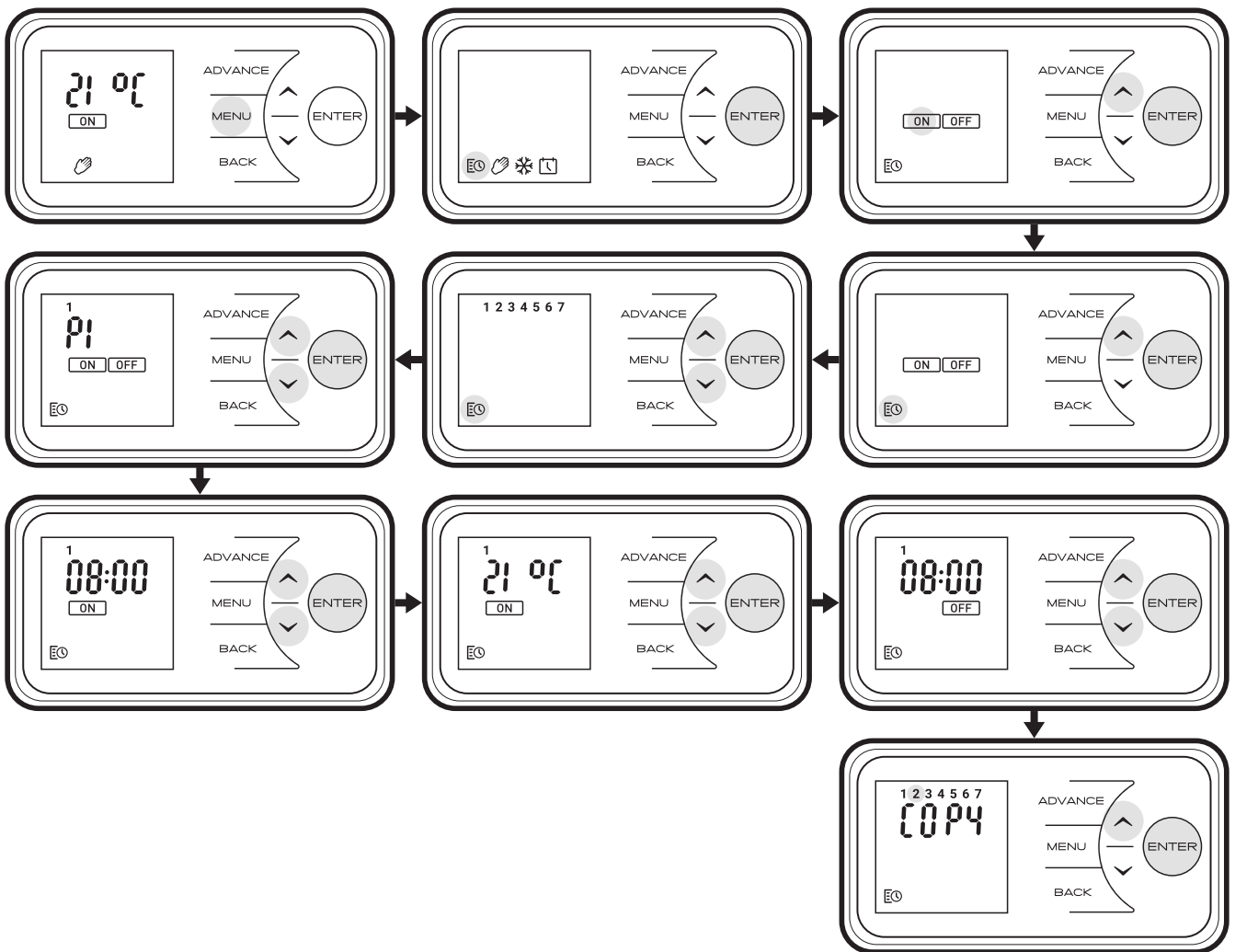

Once P1-P4 heating programmes have been set, COPY will flash on the screen. To copy newly programmed P1-P4 heating programmes to other days press the Enter button.

COPY will be displayed on screen and the next day in sequence will flash at the top of the screen, To copy to the next day in the sequence, press Up button, to deselect the next day in sequence press Enter button.

The days of the week that are selected will be displayed at the top of the screen. The days that have been deselected will not be visible (see Diagrams).



Press Enter to confirm, backlight will flash and return to the User Timer screen. With **ON** highlighted press the Enter Button to activate User Timer, the backlight will flash and the screen will return to the home screen.

Setting Modes

 Manual Mode - To choose a constant heat mode. This mode ignores the User Timer and maintains the displayed temperature.

- Press Menu Button
- Press Up to highlight the Hand icon
- Press Enter Button
- Ensure **ON** is highlighted
- Press Enter Button
- Use Down and Up to adjust to the desired temperature
- Press Enter to Confirm

 Frost protect - Frost protect mode maintains a room temperature of 7°C throughout a 24 hour period. This mode should be used to provide protection against frost as indicated by the Frost icon.

- Press the Menu button
- Press Up twice to highlight the snowflake icon
- Press Enter to access the  Frost protect menu
- Press Down or Up to adjust the  Frost protect temperature setting
- Press Enter to confirm

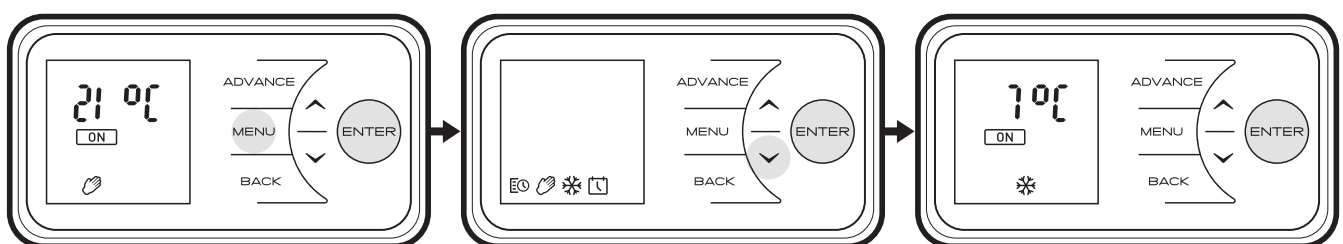

Standby - Select standby to switch off the heating element. Heat will not be provided.

To activate standby:

- Press Menu button
- Press Up to highlight the Hand icon
- Toggle to Off
- Press Enter to confirm

The screen will appear blank

Advance

Sometimes you may be at home when you had not planned to be or need to leave when you had planned to have heating on. You can change the way you use your heating temporarily; this temporary change is achieved using the Advance function.

When a timer has been selected, the Advance function allows you to begin the next period early. If the heater is in a Comfort Off period and you want heat - press the Advance button. The Advance icon  will be displayed on the screen. If the heater is in the Comfort On and you don't want heat, press the Advance button and it will go off until the beginning of the next Comfort On Period.

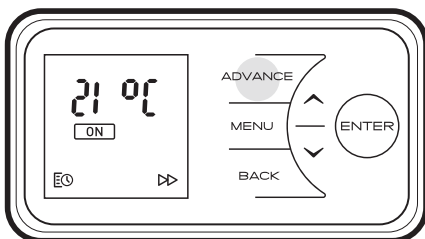

Options

DST Rule - Select your daylight saving setting. The heater clock will automatically adjust for daylight saving time. If no adjustment is required then select off.

- Press the Menu button
- Press Up button 3 times
- Press Enter when the  Date & time Icon is highlighted
- Press Down or Up to Enter DST screen
- Press Enter to adjust DST
- Press Down or Up to toggle DST on/off
- Press Enter to confirm

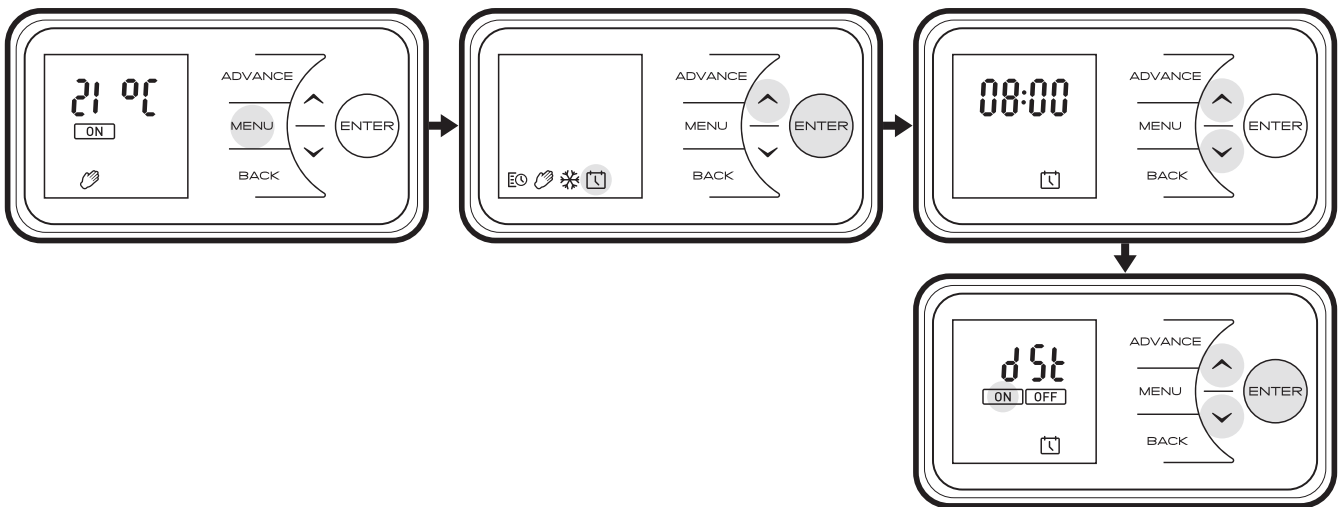

Sound - Audio feedback can be enabled or disabled.

- Press the Menu, Back and Enter buttons and hold for 10 seconds
- Press Up button 2 times
- Press Enter when the Sound Icon is highlighted
- Press Down or Up to toggle audio feedback on/off
- Press Enter to confirm

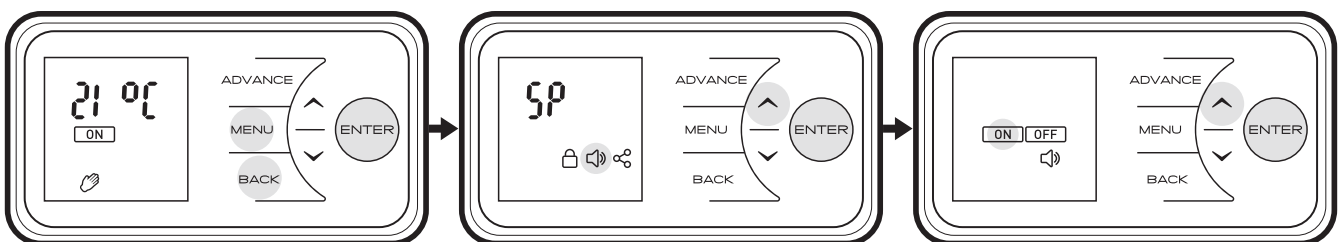

Comms - Choose to enable or disable Bluetooth pairing function.
Bluetooth is disabled by default.

Bluetooth

- Press the **Menu**, **Back** and **Enter** buttons and hold for 10 seconds
- The Setpoint menu will be displayed.
- Press **Up** 3 times to highlight the Comms icon
- Press **Enter** to enter the Comms menu
- Press **Enter** to access the Bluetooth (BT) menu
- Press **Down** or **Up** to toggle Bluetooth on/off
- For Bluetooth on, highlight **ON** and press **Enter** button
- Home screen will now display coms icon.

When pairing with a mobile device the 6 digit pairing code will display on the screen automatically. Initially the first three digits (example: -000) will be displayed. Use the up/down arrow keys to display the next three (example: 000-).

- Confirmation screen will show Bluetooth pairing code, Comms symbol will flash while “advertising” Bluetooth. Enter this code to mobile device.
- Press **Enter** to confirm

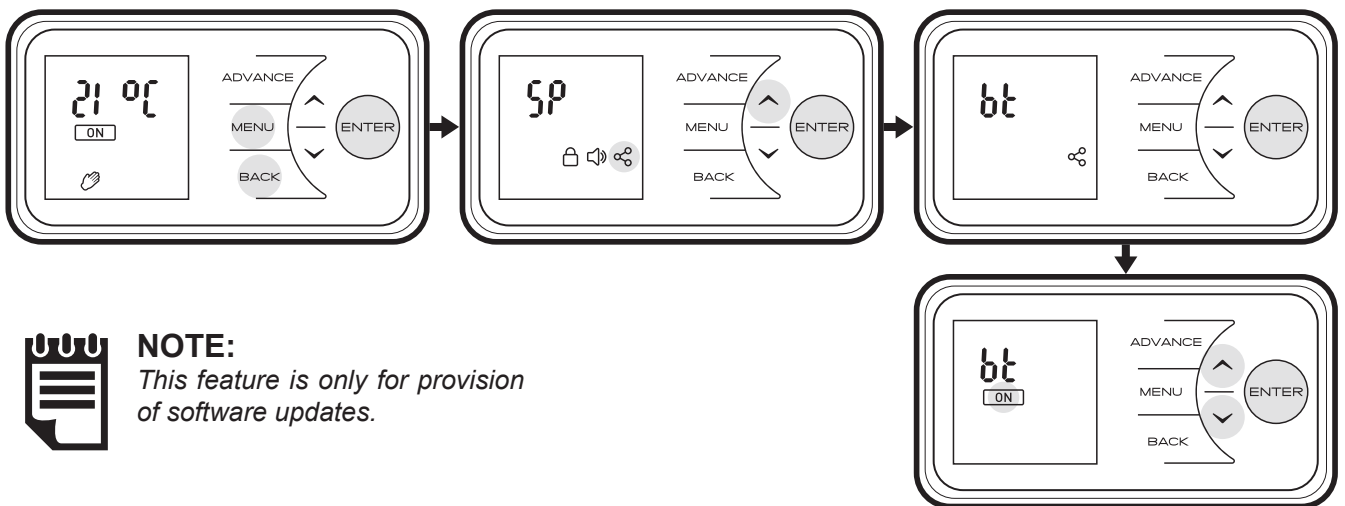

NOTE:

This feature is only for provision of software updates.

User Information



Temp units - Choose whether your unit displays degrees Celsius or degrees Fahrenheit

Setpoint - The heater comes from the factory with a temperature setting range of 7°C - 26°C.

The maximum temperature setting can be increased to 32°C using the Setpoint Function.

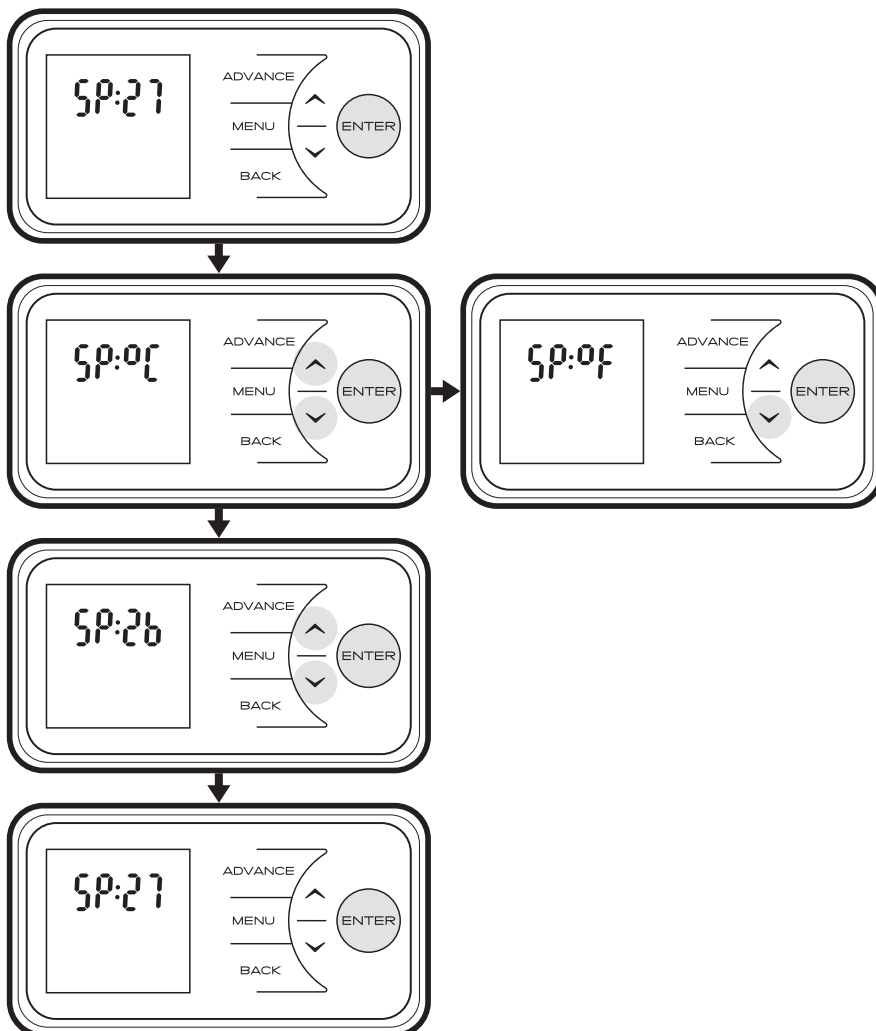
- Press the Menu, Back and Enter buttons and hold for 10 seconds
- The Set Point menu will be displayed.
- Press Enter to view the SP menu
- Press Down or Up to toggle between °C and °F
- Press Enter button to Confirm
- Press Down or Up to adjust the set point temperature
- Press Enter button to Confirm



Adaptive Start  - to achieve the desired temperature at the onset of the timed ON period the appliance anticipates when it needs to start heating prior to the onset of the timed period. E.g. room is 16°C, with 21°C at 7am set on the timer. With Adaptive Start  on the control will start to heat the room before 7am, reaching 21°C at this time. With Adaptive Start  off the heater will start to heat the room at 7am and will reach 21°C after this time.

- Press the Menu and Advance buttons and hold for 5 seconds
- The Advance menu is displayed
- Press Up twice to highlight the  icon
- Press Enter to access the Adaptive Start menu
- Press Down or Up to toggle Adaptive Start on/off
- Press Enter to confirm. Icon displayed on screen.

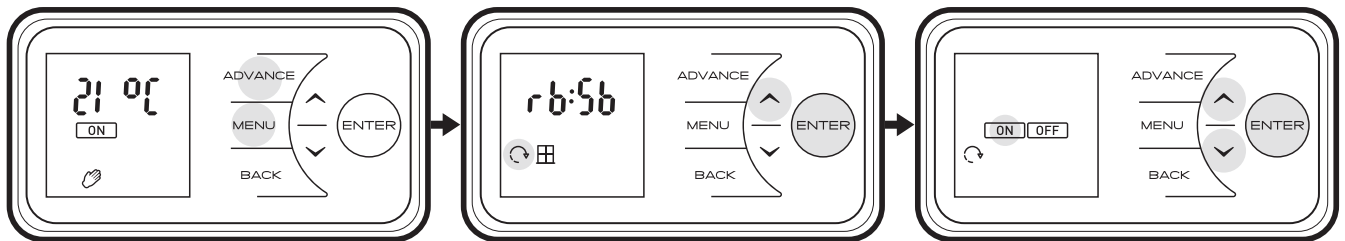

Open Window - The heater comes with a feature that will detect if a window is open and heat is being lost, so the heater will enter a reduced-power mode instead of using unnecessary energy. Open Window detection is activated by default. To activate/deactivate this feature:

- Press the Menu and Advance buttons and hold for 5 seconds
- The Advance menu is displayed
- Press Up three times to highlight the window icon
- Press Enter to access the  menu
- Press Down or Up to toggle Open Window on/off
- Press Enter to confirm

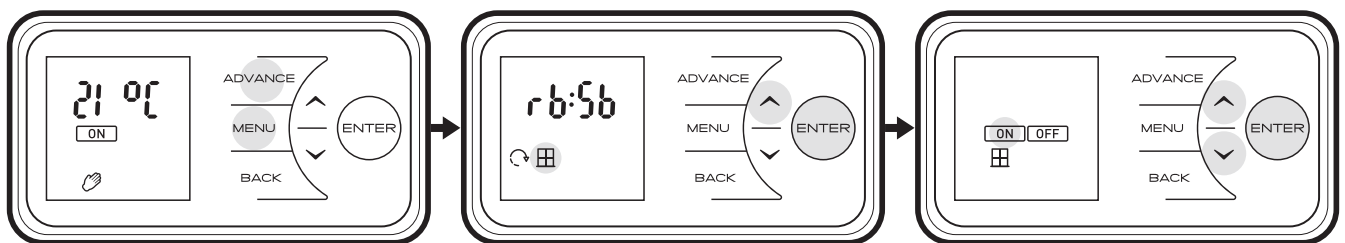

If Open Window detection is activated an Error Message will be displayed if the Heater detects an open Window "Err 2" will be displayed and the backlight & icon will flash.

Hold the Enter button for 10 seconds to cancel the error message

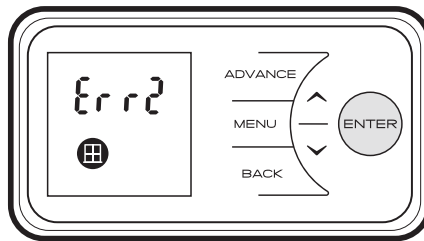

NOTE:

In environments where the product may read sudden decreases in temperature, this feature may activate in error. This can occur in drafty or poorly insulated environments as well as if the heater is undersized for the room. This feature should be disabled using the instructions above if activating for reasons other than the intended purpose. If you think that your environment is not as described here and this feature is activating, please contact our customer care team with the details on the rear page of this document.

Factory reset - Returns all settings to factory pre-sets.

- Press & hold Enter button for 5 seconds
- Press Down or Up to view Factory reset screen
- Press Enter to see factory reset options
- Press Down or Up to toggle between Y and N for reset.
- Press Enter to confirm

Factory reset sequence will now take place, you will then be prompted to reset the time/date, see "Setting the Time and Date" on page 12.

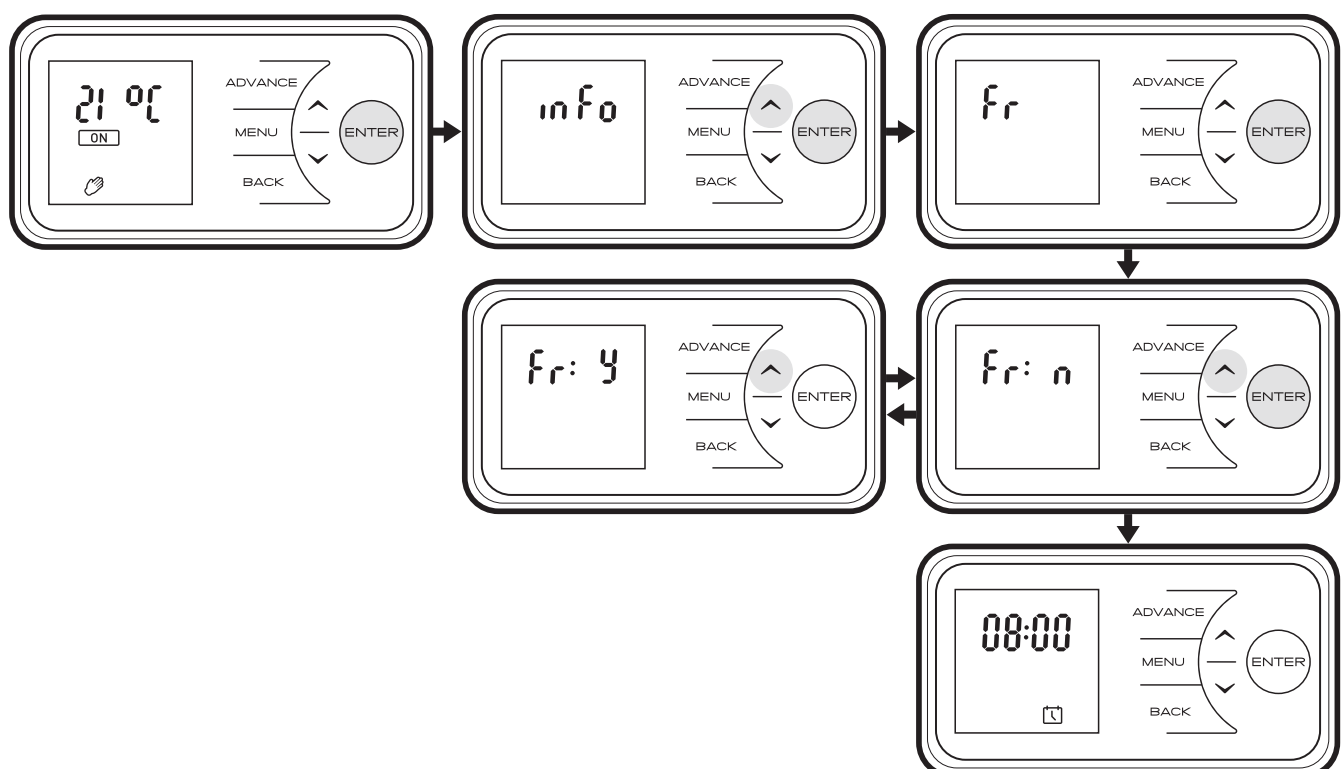

Service/User Info – Service info is displayed: UI rev, product ID

- Press & hold Enter button for 5 seconds
- Press Enter to view Info screen
- Press Enter to view UI revision number
- Press Back to return to UI screen
- Press Up to move to product ID screen
- Press Enter to view Product ID number
 - Product ID is a 12 digit code, spread across 3 screens
- Press Down or Up to scroll through the ID number
- Press Enter to return to product ID screen

Press Back 3 times to return to the home screen.

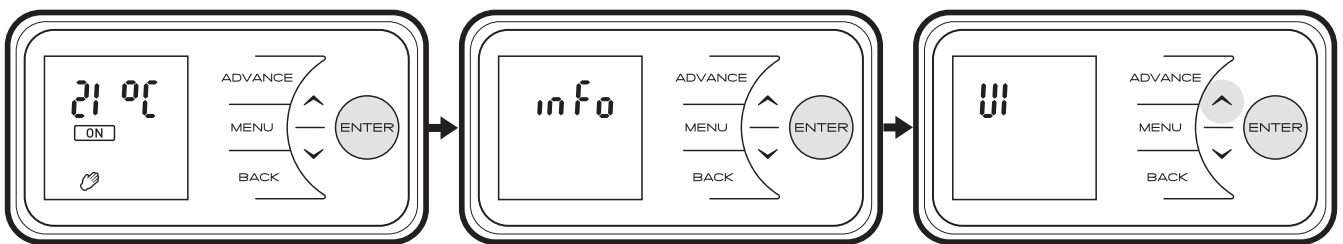

Error Messages

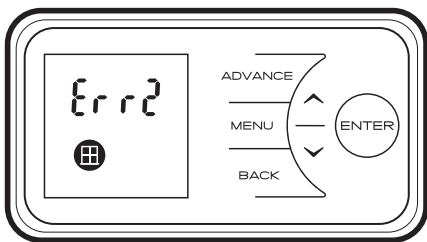

Error message 2 will be displayed when the product detects an open window in the room.

This error can be cleared by holding the Enter button for 10 seconds. Refer to the Open Window Detection Function described on page 20 and 21 for further details.

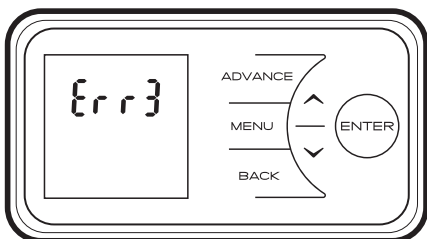

Error message 3 will be displayed on screen if the product has overheated.

This error can be cleared by removing the obstruction from the heater then holding the Enter button for 10 seconds.

Battery Replacement

IMPORTANT: Before replacing the battery ensure the heater is isolated from the electricity supply. **NOTE -** Battery should be disposed of in an appropriate manner

This product is fitted with a replaceable battery in the controls. To replace the battery, follow the steps below, shown in Fig. 5:

1. Unhinge the heater from the wall using the clips shown in Fig. 2 and locate the battery module
2. Slide the catch and pull module from the controls.
3. Remove the coin cell battery and replace with a new 3.3V type CR2032, T85°C coin cell battery.
4. Slide module back in place, ensuring clip is engaged.

Fig. 5

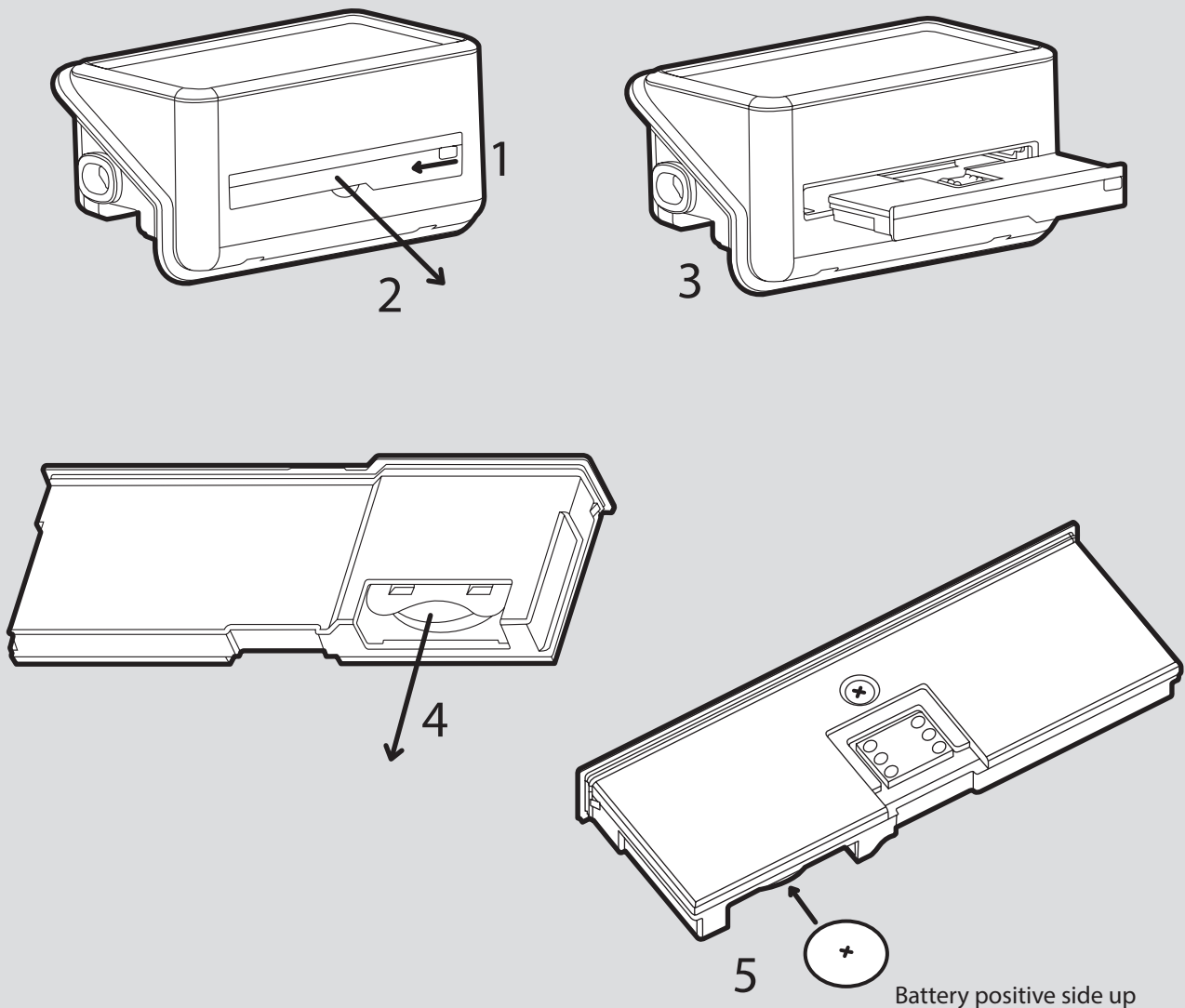

Important

During the initial operation, some odour may be noticed due to the newness of materials used in manufacture. This is normal and will disappear after a short period of use. It is however advisable to keep the room well ventilated.

Cleaning

WARNING - ALWAYS DISCONNECT FROM THE POWER SUPPLY BEFORE CLEANING THE HEATER.

Before commencing cleaning, isolate the heater from the electrical supply and allow it to cool. The outside can be cleaned by wiping it over with a soft damp cloth and then dried. Do not use abrasive cleaning powders or furniture polish, as this can damage the surface finish. To release the heater from the wall bracket for cleaning or redecoration, depress the latch on both brackets (See Fig. 2) and hinge forward.

Your Guarantee



To view the full guarantee terms and conditions scan this QR code using your smartphone or go to <https://www.gdhv.co.uk/guarantee-terms-and-conditions>.

Your Sunhouse product is manufactured by Glen Dimplex UK operating as Glen Dimplex Heating & Ventilation. GDHV designs and manufactures products to ensure they deliver reliable service for normal use in domestic dwellings and, where specified by us, in light commercial premises.

GDHV products are individually tested before leaving the factory, Your product comes with a 2 year parts and labour guarantee for repair or replacement of faulty goods and/or partial refund in the event that a repair or replacement is not available.

Your guarantee is provided by Glen Dimplex UK Ltd operating as Glen Dimplex Heating & Ventilation Ltd, Millbrook House, Grange Drive, Southampton SO30 2DF. Terms and conditions apply.

The GDHV guarantee does not in any way diminish or affect your statutory consumer rights in connection with your product.



If you experience a problem with your product during or after the guarantee period, visit our online help centre:

help.gdhv.co.uk/support/home

Please note for support you will need the model and serial number of your product and a description of the fault which has occurred.

Recycling



For electrical products sold within the European Community. At the end of the electrical products useful life it should not be disposed of with household waste. Please recycle where facilities exist. Check with a Local Authority or retailer for recycling advice in your country. Batteries should be disposed of or recycled in accordance with WEEE Directive 2012/19/EU. Packaging should be recycled where possible.

www.dimplex.co.uk

Sunhouse

Glen Dimplex Heating and Ventilation,
Millbrook House, Grange Drive, Hedge End, Southampton, SO30 2DF
Glen Dimplex Europe, Airport Road, Cloghran, Co Dublin, K67 VE08